

RÉVO+

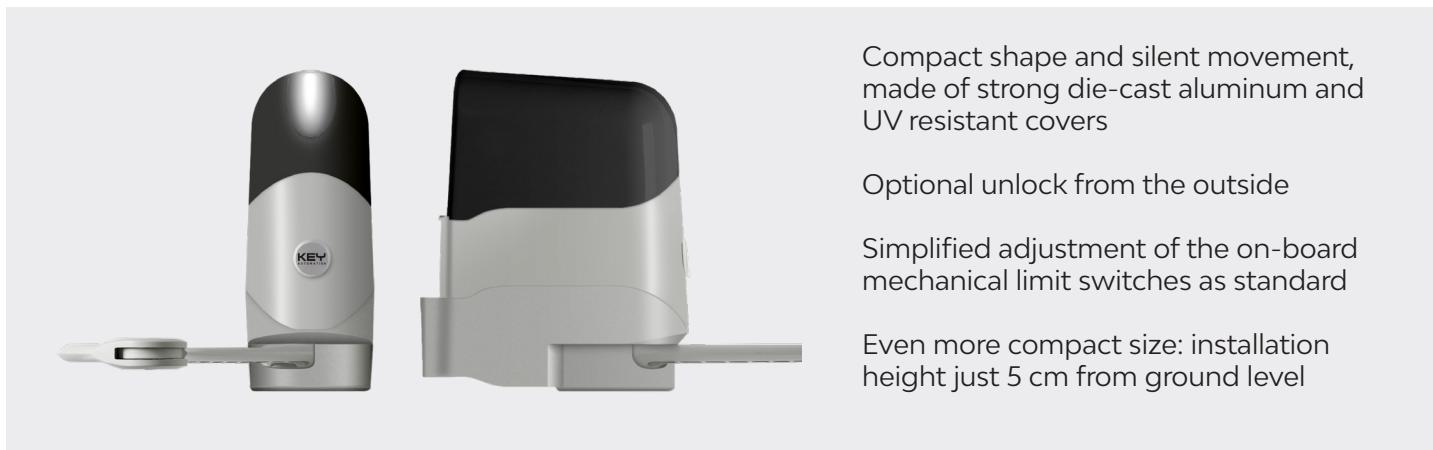

**ELECTROMECHANICAL GEAR
MOTOR WITH ARTICULATED ARM
FOR SWING GATES**

KEY
AUTOMATION



Compact shape and silent movement, made of strong die-cast aluminum and UV resistant covers

Optional unlock from the outside

Simplified adjustment of the on-board mechanical limit switches as standard

Even more compact size: installation height just 5 cm from ground level

NIGHT LIGHT SYSTEM





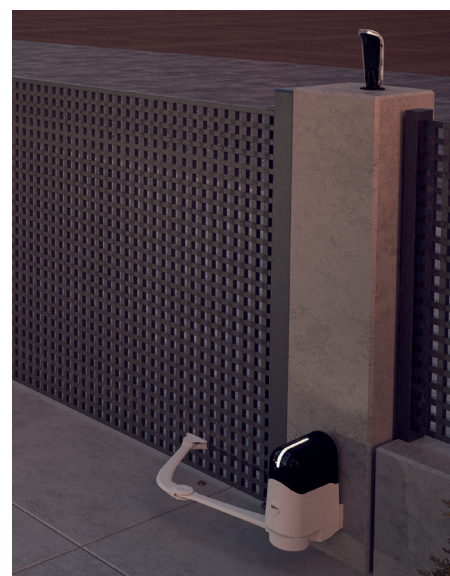

Concept that combines the comfort of an automatic gate with the use of LED lighting to illuminate your entrance over night

- + SAFETY
- + COMFORT
- + SAVING

Ease the night vision
Defines the driveway passage during the night
Allows lower power consumption



MODELS

CODE	DESCRIPTION	PCS PALLET
 REP2024 	For swing gates with maximum length 2,3 m or weight 250 kg per leaf, 24 Vdc motor	5 
 REP2024S 	For swing gates with maximum length 2,3 m or weight 250 kg per leaf, 24 Vdc motor. Without control unit	5 

 INDICATES PRODUCTS WITH DELIVERY DATES WITHIN 6 WEEKS

DIMENSIONS

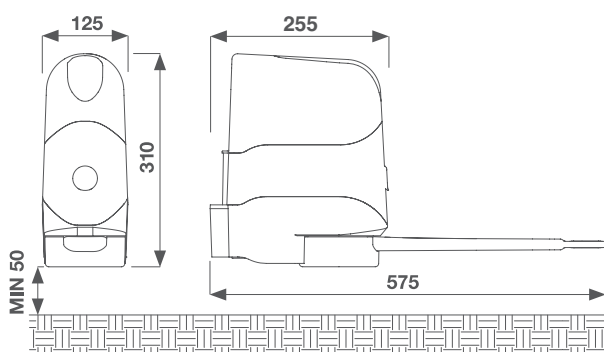

A min	100
C max	200
D min	450

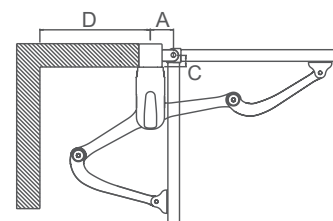

TECHNICAL DATA

		REP2024	REP2024S
MECHANICAL DATA			
torque	Nm	120	120
working cycle	%	80	80
opening time at 90°	sec	14-20	14-20
ELECTRICAL DATA			
control board		14A	-
power	Vac	230	-
	Vdc	-	24
consumption	A	0,6	2
absorbed power	W	115	50
integrated lights		yes	yes
GENERIC DATA			
protection degree	IP	44	44
dimensions (L - D - H)	mm	125 - 255 - 310	125 - 255 - 310
weight	kg cad	13	10
working temperature	°C	-20 + 55	-20 + 55
leaves maximum weight	Kg	250	250

LIMIT USE

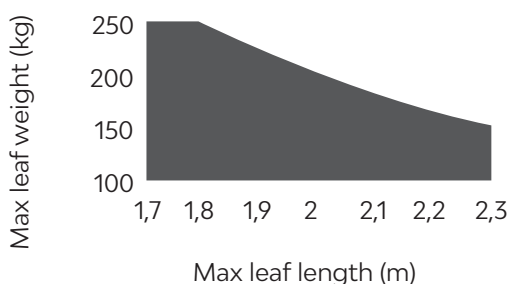

Gate shape and height and weather conditions can considerably reduce the values shown above, in the graph.

ACCESSORIES

 <p>ELS-C 12 V horizontal electric lock. Up to 2000 Kg</p> <p>PC 1</p>	 <p>KBPN Kit of 1.3 Ah lead battery and battery charger</p> <p>PC 1</p>	 <p>KC Unlock key cylinder</p> <p>PC 1</p>	 <p>REV1 Slide arm</p> <p>PC 1</p>	 <p>REV2 Arm for reduced openings</p> <p>PC 1</p>
 <p>REV3 External release unlock kit</p> <p>PC 1</p>	 <p>BMET Metal box with release system</p> <p>PC 1</p>	 <p>550CABL045A00 * Special cable for Eclipse flash light RG174 50 Ohm + 4 x 0,50 mm² (100m)</p> <p>PC 1</p>	 <p>DYL Programming module Cable length 120 cm (only 14A board)</p> <p>PC 1</p>	 <p>KUBEPRO Wireless programming module</p> <p>PC 1</p>
 <p>KUBE Wireless controlling module for end user</p> <p>PC 1</p>				

* it is not recommended to use a connection longer than 4 m to avoid sensible loss of reach



Compact shape and silent movement, made of strong die-cast aluminum and UV resistant covers

Simplified adjustment of the on-board mechanical stops, mechanical limit switches as standard

Even more compact size: installation height just 5 cm from ground level

CONTROL UNIT CT20324

+ CT20324

New 5-character / 16-segment display for more natural and intuitive reading

+ KUBE and KUBE PRO

Optional programming with KUBE PRO wireless module (from FW version 2.0)

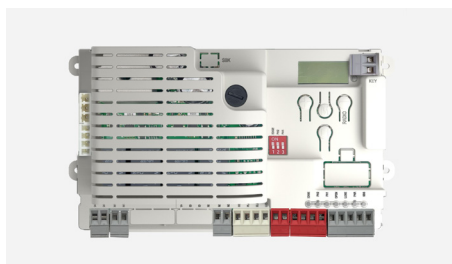

MODELS

CODE	DESCRIPTION	PCS PALLET
REP2324	For swing gates with maximum length 2,3 m or weight 250 kg per leaf, 24 Vdc motor, With control unit	5
REP2224S	For swing gates with maximum length 2,3 m or weight 250 kg per leaf, 24 Vdc motor. Without control unit	5

INDICATES PRODUCTS WITH DELIVERY DATES WITHIN 6 WEEKS

DIMENSIONS

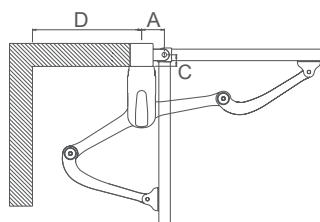
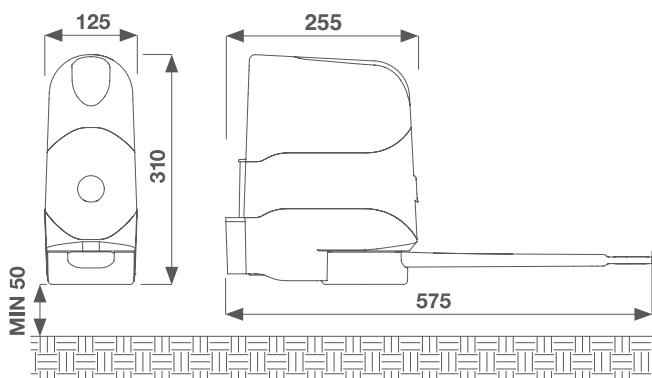

A min	100
C max	200
D min	450

TECHNICAL DATA

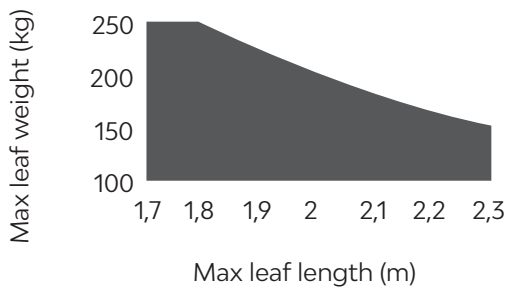

		REP2324	REP2324S
MECHANICAL DATA			
torque	Nm	120	120
working cycle	%	80	80
opening time at 90°	sec	14-20	14-20
ELECTRICAL DATA			
control board		CT20324	-
power	Vac	230	-
	Vdc	-	24
consumption	A	0,65	2
absorbed power	W	115	50
GENERIC DATA			
protection degree	IP	44	44
dimensions (L - D - H)	mm	125 - 255 - 310	125 - 255 - 310
weight	kg cad	13,5	10
working temperature	°C	-20 + 55	-20 + 55
leaves maximum weight	Kg	250	250

LIMIT USE



Gate shape and height and weather conditions can considerably reduce the values shown above, in the graph.

ACCESSORIES

 <p>ELS-C 12 V horizontal electric lock. Up to 2000 Kg</p> <p>PC 1</p>	 <p>KBPN Kit of 1.3 Ah lead battery and battery charger</p> <p>PC 1</p>	 <p>KC Unlock key cylinder</p> <p>PC 1</p>	 <p>REV1 Slide arm</p> <p>PC 1</p>	 <p>REV2 Arm for reduced openings</p> <p>PC 1</p>
 <p>REV3 External release unlock kit</p> <p>PC 1</p>	 <p>BMET Metal box with release system</p> <p>PC 1</p>	 <p>KUBEPRO Wireless programming module</p> <p>PC 1</p>	 <p>KUBE Wireless controlling module for end user</p> <p>PC 1</p>	